



POLIMOVILRUEDAS

RUEDAS INDUSTRIALES . PARA MUEBLES . NEUMÁTICAS . DE ACERO INOXIDABLE

Accesorios y varios



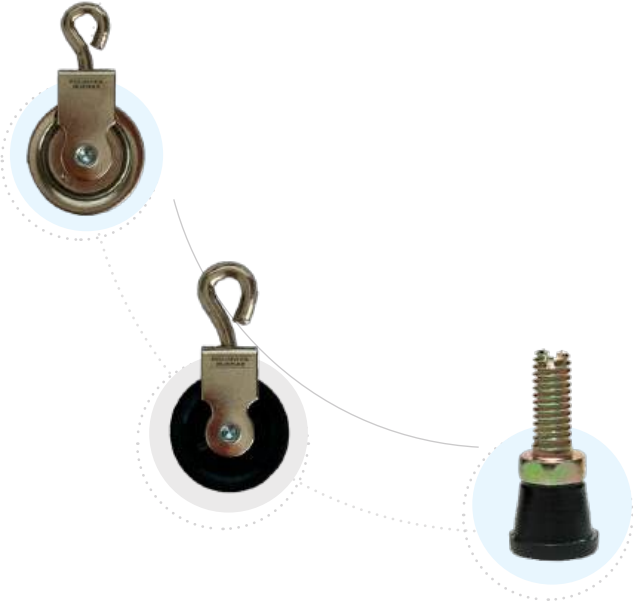



Índice

Quiénes Somos	4
Interpretación del Código	4
Referencias	5
Accesorios	
Cámaras y Cubiertas	6
Bases “U”, “L” y Cuadrada	7
Capuchones Plásticos	7
Patines	8
Roldanas	9
Regatones Plásticos	9
Regatones de Goma	12



Somos una empresa dedicada a la fabricación y distribución de ruedas industriales, para muebles, equipamiento hospitalario y usos múltiples.

Contamos con una amplia variedad de modelos y medidas para todo tipo de necesidad del mercado.

Polimovil ofrece 40 años de experiencia para solucionar sus problemas en la utilización de ruedas.

Interpretación del Código

		Tipos de Sujeción	
Primer Dígito	BG-	Base giratoria	
	BF-	Base fija	
	BGR-	Base giratoria redonda	
	BGA-	Base giratoria andamio	
	A-	Suelta	

		Tipos de Materiales	
Último Dígito	1	Hierro	
	2	Hierro y goma	
	3	Polipropileno	
	4	Goma	
	5	Nylon	
	6	Chapa y goma	
	7	Polímero y Caucho Termoplástico	
	8	Nylon y Poliuretano	
	9	Fundición y Poliuretano	
	0	Neumática	
	-8	Rodillo	
	-9	Ruleman	
	-F	Freno	
	-T	Térmica	

Ejemplo

A-1555-9

Suelta ————
 Ø 150 mm ————
 Ancho 50 mm ————
 Nylon ————
 Ruleman ————



Avenida Warnes 499, esq Malabia
C1414AAE - CAPITAL FEDERAL

TEL/FAX: (011) 4854-2564 / 4856-7266

WPP: +54 9 11 2188-1903

E-MAIL: info@polimovilruedas.com.ar
ventas@polimovilruedas.com.ar

www.polimovilruedas.com.ar



Referencias

	Altura de Rueda		Medida de la Base		Distancia entre Agujeros
	Altura de Rueda Pasante		Diámetro Base Redonda		Diámetro de Agujero
	Altura hasta el Perno		Diámetro Base del Perno		Diámetro del Perno
	Diámetro de Rueda		Diámetro del Eje		Capacidad de Carga
	Ancho de Rueda		Ancho de Rueda Doble		



• LAS MEDIDAS SON APROXIMADAS Y ESTÁN EXPRESADAS EN MILÍMETROS

• LAS FOTOS SON ILUSTRATIVAS



Cámaras y Cubiertas



• CÁMARAS Y CUBIERTAS DE DISTINTAS MEDIDAS Y CALIDADES.

• REPUESTOS PARA TODO TIPO DE CARROS DE CARGA, VERDULEROS, PARA TUBOS DE GAS, BIDONES, ZORRAS, CARRETILLAS, ENTRE OTROS.



Cámaras

CÓDIGO	MEDIDA	PICO	TIPO
C2504	250-4 / 280 250-4	CURVO	ESTÁNDAR
C3504	350-4 / 300-4	CURVO	ESTÁNDAR
C3506	350-6	RECTO	ESTÁNDAR
C3508	350-8	RECTO	ESTÁNDAR
C4008	400-8	RECTO	ESTÁNDAR



Cámaras Reforzadas

CÓDIGO	MEDIDA	PICO	TIPO
CR20050	200 x 50	CURVO	REFORZADA
CR2504	250-4 / 280 250-4	CURVO	REFORZADA
CR3504	350-4 / 300-4	CURVO	REFORZADA
CR3506	350-6	RECTO	REFORZADA
CR3508	350-8	RECTO	REFORZADA
CR4008	400-8	RECTO	REFORZADA



Cubiertas

CÓDIGO	MEDIDA	DIBUJO	TIPO
CU2504	250-4	TRACTOR	ESTÁNDAR
CU2802504	280 250-4	ZIG-ZAG	ESTÁNDAR
CU3504	350-4 / 300-4	TAQUITO	ESTÁNDAR
CU3506	350-6	TAQUITO	ESTÁNDAR
CU3508	350-8	RAYADA	ESTÁNDAR
CU4008	400-8	TAQUITO	ESTÁNDAR



Cubiertas Reforzadas

CÓDIGO	MEDIDA	DIBUJO	TIPO
CUR20050	200 x 50	RAYADA	REFORZADA
CUR2504	250-4	ZIG-ZAG	REFORZADA
CUR3504	350-4 / 300-4	TAQUITO	REFORZADA
CUR4008	400-8	TAQUITO	REFORZADA



Bases "U", "L" y Cuadrada



- DIVERSAS BASES PARA PONER A ROSCA DE 5/16"
- PARA ANCLAR RUEDAS A TODO TIPO DE MUEBLES.
- TAMBIÉN COMPATIBLES CON NUESTROS PATINES PLÁSTICOS.

Bases "U", "L" y Cuadrada

CÓDIGO	DESCRIPCIÓN	ROSCA	COLOR
BR-2T	BASE RECTANGULAR 2 TORNILLOS	5/16"	NEGRO
BR-4T	BASE CUADRADA 4 TORNILLOS	5/16"	NEGRO
BU-15	BASE U 15 mm	5/16"	NEGRO
BU-18	BASE U 18 mm	5/16"	NEGRO
BU-25	BASE U 25 mm	5/16"	NEGRO
BL-18	BASE L 18 mm	5/16"	NEGRO
BL-25	BASE L 25 mm	5/16"	NEGRO



Capuchones Plásticos



- PARA CLAVAR EN PERNO ESTRIADO DE 8 mm.
- SE COLOCA A PRESIÓN.
- SE UTILIZAN EN CONJUNTO CON LAS RUEDAS DUALES DE NYLON PARA APLICAR CON MUEBLES QUE SEAN DE CAÑO.

Capuchones de Plástico

CÓDIGO	DESCRIPCIÓN	MEDIDAS	COLOR
CP01	CAPUCHÓN P/ CAÑO	20 x 20	NEGRO
CP02	CAPUCHÓN P/ CAÑO	25 x 25	NEGRO
CP03	CAPUCHÓN P/ CAÑO	11 mm	NEGRO
CP04	CAPUCHÓN P/ CAÑO	1/2"	NEGRO
CP05	CAPUCHÓN P/ CAÑO	5/8"	NEGRO
CP06	CAPUCHÓN P/ CAÑO	3/4"	NEGRO
CP07	CAPUCHÓN P/ CAÑO	7/8"	NEGRO
CP08	CAPUCHÓN P/ CAÑO	1"	NEGRO
CP09	CAPUCHÓN P/ CAÑO	1" 1/4	NEGRO
CP10	CAPUCHÓN P/ CAÑO	1" 1/2	NEGRO
CP11	CAPUCHÓN P/ CAÑO	1" 3/4	NEGRO

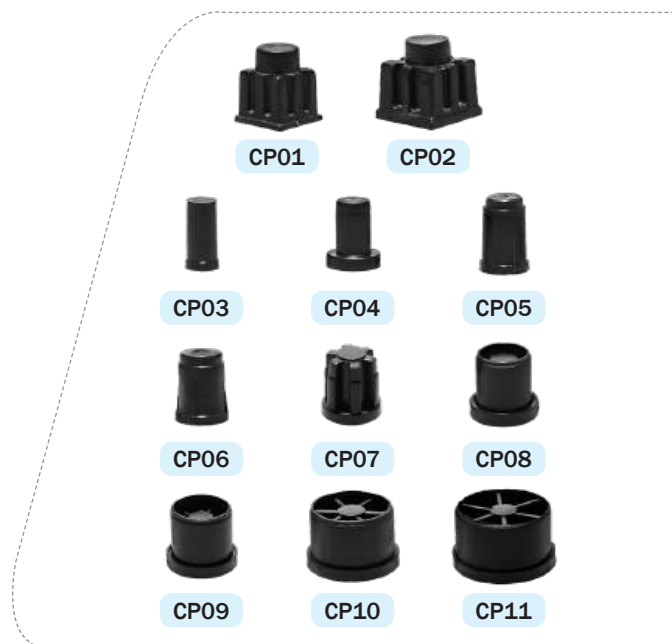



Patines



• IDEALES PARA DARLE ELEVACIÓN Y ESTABILIDAD A TUS MUEBLES

• APLICABLES EN MESAS, SILLAS, BIBLIOTECAS, MUEBLES, PANELES, MUEBLES DE COCINA, DIVISORES, ENTRE OTROS.

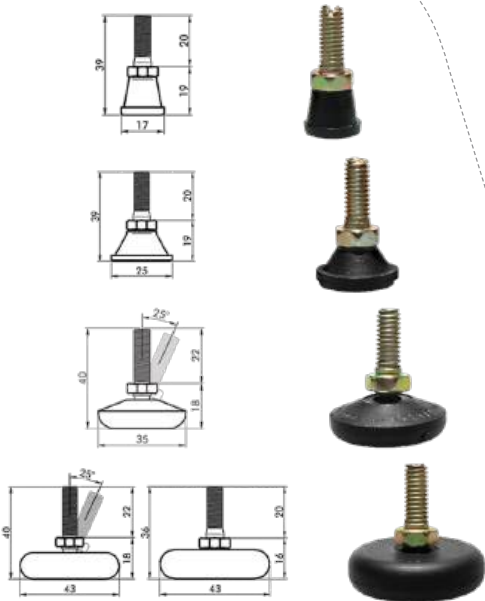

Patines de Nylon

CÓDIGO	DIÁMETRO	PERNO	TIPO
PNF-1701	17 mm	5/16"	FIJO
PNF-1702	17 mm	3/8"	FIJO
PNF-2501	25 mm	1/4"	FIJO
PNF-2502	25 mm	5/16"	FIJO
PNF-3001	30 mm	5/16"	FIJO
PNF-3002	30 mm	3/8"	FIJO
PNM-3501	35 mm	5/16"	MÓVIL
PNM-3502	35 mm	3/8"	MÓVIL
PNM-3503	35 mm	ESTRIADO	MÓVIL
PNM-3504	35 mm	11 mm A PRESIÓN	MÓVIL
PNF-4301	43 mm	5/16"	FIJO
PNF-4302	43 mm	3/8"	FIJO
PNM-4301	43 mm	5/16"	MÓVIL
PNM-4302	43 mm	3/8"	MÓVIL
PNM-4303	43 mm	11 mm	MÓVIL
PNM-4601	46 mm	5/16"	MÓVIL

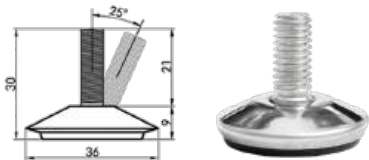

Patines de Acero

CÓDIGO	DIÁMETRO	PERNO	TIPO
PAM-3601	36 mm	5/16"	MÓVIL
PAM-3602	36 mm	3/8"	MÓVIL



Pata Regulable de Goma

CÓDIGO	DIÁMETRO	PERNO	TIPO
PGF-3001	30 mm	5/16"	FIJO
PGF-5001	48 mm	3/8"	FIJO
PGF-5002	52 mm	M10	FIJO





Roldanas





- ROLDANAS DE ESTRUCTURA METÁLICA CON RUEDAS PLÁSTICAS O DE METAL.
- PARA TOLDOS, CORTINAS Y SOGAS DE TENDIDO DE PRENDAS.

Roldanas con Ruedas Plásticas

CÓDIGO			COLOR
ROL-213	25	10	PLÁSTICO
ROL-313	32	10	PLÁSTICO
ROL-413	38	10	PLÁSTICO
ROL-513	50	10	PLÁSTICO



Roldanas de Metal

CÓDIGO			COLOR
ROL-211	25	10	METAL
ROL-411	38	10	METAL
ROL-511	50	10	METAL



Regatones Plásticos



- AMPLIA VARIEDAD.
- CONSULTE COLORES.
- PARA MÁS INFORMACIÓN, CONSULTE NUESTRO CATÁLOGO DE REGATONES. EN EL MISMO ENCONTRARÁ TODAS LAS MEDIDAS E IMÁGENES RESPECTIVAS.

Tetones

CÓDIGO	DIÁMETRO TETÓN	TIPO DE BASE	COLOR
RP1401	8 mm	GRANDE	NEGRO
RP1402	8 mm	CHICA ANTI-DESPLIZANTE	NEGRO
RP1403	8 mm	CHICA POLIETILENO	NEGRO



Ángulos

CÓDIGO	DIÁMETRO	ÁNGULO	COLOR
RP1501	3/4"	90 GRADOS	NEGRO
RP1502	7/8"	90 GRADOS	NEGRO
RP1503	1"	90 GRADOS	NEGRO
RP1504	1" 1/4	90 GRADOS	NEGRO
RP1505	1" 1/2	90 GRADOS	NEGRO



Varios

CÓDIGO	TIPO	COLOR
RP1601	PUÑO FRENO	NEGRO
RP1602	SOPAPITA	TRANSPARENTE
RP1603	TAPÓN MACIZO 1" 1/8	NEGRO
RP1604	REGATÓN PARA CHAPA	BLANCO
RP1605	BASE RECTANGULAR PARA MADERA	NEGRO





Regatones Plásticos

Exteriores Cortos

CÓDIGO	DIÁMETRO	TIPO	COLOR
RP0101	1/2"	CORTO	NEGRO
RP0102	5/8"	CORTO	NEGRO
RP0103	3/4"	CORTO	NEGRO
RP0104	7/8"	CORTO	NEGRO
RP0105	1"	CORTO	NEGRO
RP0106	1" 1/8"	CORTO	NEGRO
RP0107	1" 1/4"	CORTO	NEGRO
RP0108	1" 1/2"	CORTO	NEGRO
RP0109	2"	CORTO	NEGRO
RP0110	3"	CORTO	NEGRO



Exteriores Largos

CÓDIGO	DIÁMETRO	TIPO	COLOR
RP0201	5/8"	LARGO	NEGRO
RP0202	3/4"	LARGO	NEGRO
RP0203	7/8"	LARGO	NEGRO
RP0204	1"	LARGO	NEGRO



Balitas Largas

CÓDIGO	DIÁMETRO	ALTURA TOTAL	COLOR
RP0301	3 mm	14 mm	NEGRO
RP0302	4 mm	14 mm	NEGRO
RP0303	4,75 mm	14 mm	NEGRO
RP0304	5 mm	14 mm	NEGRO
RP0305	6 mm	14 mm	NEGRO
RP0306	8 mm	17 mm	NEGRO
RP0307	10 mm	20 mm	NEGRO
RP0308	12 mm	30 mm	NEGRO
RP0309	14 mm	28 mm	NEGRO



Interiores

CÓDIGO	DIÁMETRO	TIPO	COLOR
RP0401	5 mm	CURVO	NEGRO
RP0402	9 mm	CURVO	NEGRO
RP0403	9 mm	PLANO	NEGRO
RP0404	11 mm	CURVO	NEGRO
RP0405	5/8"	PLANO	NEGRO
RP0406	3/4"	CURVO	NEGRO
RP0407	7/8"	PLANO	NEGRO
RP0408	1"	PLANO	NEGRO
RP0409	1"	MEDIA ESFERA	NEGRO
RP0410	1" 1/8"	PLANO	NEGRO
RP0411	1" 1/4"	PLANO	NEGRO
RP0412	1" 1/2"	PLANO	NEGRO
RP0413	1" 3/4"	PLANO	NEGRO
RP0414	2"	PLANO	NEGRO
RP0415	2" 1/2"	PLANO	NEGRO
RP0416	3"	PLANO	NEGRO
RP0417	4"	PLANO	NEGRO

Interiores Aletados

CÓDIGO	DIÁMETRO	TIPO	COLOR
RP0501	5/8"	APILABLE	NEGRO
RP0502	3/4"	APILABLE	NEGRO
RP0503	5/8"	-	NEGRO
RP0504	3/4"	-	NEGRO
RP0505	7/8"	-	NEGRO
RP0506	1"	-	NEGRO
RP0507	1" 1/8"	-	NEGRO



Interiores Doble Labio

CÓDIGO	DIÁMETRO	TIPO	COLOR
RP0601	3/4"	DOBLE LABIO	NEGRO
RP0602	7/8"	DOBLE LABIO	NEGRO
RP0603	1"	DOBLE LABIO	NEGRO
RP0604	1" 1/4"	DOBLE LABIO	NEGRO
RP0605	1" 1/2"	DOBLE LABIO	NEGRO
RP0606	2"	DOBLE LABIO	NEGRO



Cuadrados

CÓDIGO	MEDIDAS	TIPO	COLOR
RP0701	15 x 15	ALETADO	NEGRO
RP0702	20 x 20	PLANO	NEGRO
RP0703	20 x 20	HOTELERO	NEGRO
RP0704	25 x 25	PLANO	NEGRO
RP0705	30 x 30	PLANO	NEGRO
RP0706	35 x 35	PLANO	NEGRO
RP0707	40 x 40	PLANO	NEGRO
RP0708	40 x 40	PARED 09	NEGRO
RP0709	50 x 50	PLANO	NEGRO
RP0710	50x50	CURVO	NEGRO
RP0711	50 x 50	EXTERIOR	NEGRO
RP0712	60 x 60	PLANO	NEGRO
RP0713	80 x 80	PLANO	NEGRO
RP0714	100 x 100	PLANO	NEGRO



Abraza Caños

CÓDIGO	DIÁMETRO	TIPO	COLOR
RP0901	11 mm	PLANO	NEGRO
RP0902	12 mm	PLANO	NEGRO
RP0903	16 mm	PLANO	NEGRO
RP0904	3/4"	CURVO	NEGRO
RP0905	1"	CURVO	NEGRO



Macizos con Tuerca

CÓDIGO	DIÁMETRO	TIPO	COLOR
RP1001	1" 1/2	TUERCA 5/16"	NEGRO
RP1002	25 x 25	TUERCA 3/8"	NEGRO
RP1003	30 x 30	TUERCA 3/8"	NEGRO
RP1004	40 x 40	TUERCA 3/8"	NEGRO



Rectangulares

CÓDIGO	MEDIDAS	TIPO	COLOR
RP0801	10 x 20	INTERIOR	NEGRO
RP0802	10 x 20	EXTERIOR	NEGRO
RP0803	10 x 30	INT. CURVO	NEGRO
RP0804	14 x 30	ALETADO	NEGRO
RP0805	14 x 30	EXT. APILABLE	NEGRO
RP0806	15 x 25	INTERIOR	NEGRO
RP0807	15 x 30	INT. CURVO	NEGRO
RP0808	15 x 30	EXT. OVAL	NEGRO
RP0809	20 x 30	INTERIOR	NEGRO
RP0810	20 x 40	INTERIOR	NEGRO
RP0811	20 x 50	INT. ALETADO	NEGRO
RP0812	25 x 50	INTERIOR	NEGRO
RP0813	20 x 60	INT. ALETADO	NEGRO
RP0814	30 x 40	INTERIOR	NEGRO
RP0815	30 x 50	INTERIOR	NEGRO
RP0816	30 x 50	EXTERIOR	NEGRO
RP0817	30 x 60	INTERIOR	NEGRO
RP0818	30 x 70	INTERIOR	NEGRO
RP0819	40 x 60	INTERIOR	NEGRO
RP0820	40 x 80	INTERIOR	NEGRO
RP0821	50 x 100	INTERIOR	NEGRO
RP0822	50 x 100	EXTERIOR	NEGRO



Perilla con Tornillo

CÓDIGO	DIÁMETRO	LARGO DE ROSCA	COLOR
RP1101	1/4"	23 mm	NEGRO
RP1102	5/16"	21 mm	NEGRO
RP1103	3/8"	30 mm	NEGRO



Perilla con Tuerca

CÓDIGO	DIÁMETRO	TIPO	COLOR
RP1201	1/4"	PASANTE	NEGRO
RP1202	5/16"	PASANTE	NEGRO
RP1203	3/8"	CIEGA	NEGRO
RP1204	3/8"	PASANTE	NEGRO
RP1205	3/8"	GRANDE PAS.	NEGRO



Media Caña

CÓDIGO	DIÁMETRO	TIPO	COLOR
RP1301	3/4"	BOTON	NEGRO
RP1302	3/4"	PLANO	NEGRO
RP1303	1"	PLANO	NEGRO
RP1304	1"	REDONDA	NEGRO





Regatones de Goma



- AMPLIA VARIEDAD.
- DE GOMA.

- PARA MÁS INFORMACIÓN, CONSULTE NUESTRO CATÁLOGO DE REGATONES. EN EL MISMO ENCONTRARÁ TODAS LAS MEDIDAS E IMÁGENES RESPECTIVAS.

Regatones Exteriores de Goma



CÓDIGO	DIÁMETRO	TIPO	COLOR
RG0101	6mm	BAJO	NEGRO
RG0102	8mm	BAJO	NEGRO
RG0103	10mm	BAJO	NEGRO
RG0104	12mm	BAJO	NEGRO
RG0105	12mm	ALTO	NEGRO
RG0106	14mm	BAJO	NEGRO
RG0107	15mm	ALTO	NEGRO
RG0108	16mm	SILLA	NEGRO
RG0109	19mm	SILLA	NEGRO
RG0110	20mm	SILLA	NEGRO
RG0111	22mm	SILLA	NEGRO
RG0112	25mm	SILLA	NEGRO
RG0113	30mm	SILLA	NEGRO
RG0114	32mm	SILLA	NEGRO
RG0115	38mm	SILLA	NEGRO
RG0116	50mm	SILLA	NEGRO



Regatones tipo Muleta de Goma

CÓDIGO	DIÁMETRO	TIPO	COLOR
RG0201	13 mm	MULETA	NEGRO
RG0202	15 mm	MULETA	NEGRO
RG0203	16 mm	MULETA	NEGRO
RG0204	17 mm	MULETA	NEGRO
RG0205	19 mm	MULETA	NEGRO
RG0206	20 mm	MULETA	NEGRO
RG0207	22 mm	MULETA	NEGRO
RG0208	25 mm	MULETA	NEGRO

Regatones Interiores de Goma



CÓDIGO	DIÁMETRO	TIPO	COLOR
RG0301	14 mm	MACIZO	NEGRO
RG0302	17 mm	MACIZO	NEGRO
RG0303	20 mm	MACIZO	NEGRO
RG0304	23 mm	MACIZO	NEGRO
RG0305	30 mm	MACIZO	NEGRO

Regatones Cuadrados de Goma



CÓDIGO	DIÁMETRO	TIPO	COLOR
RG0501	40 x 40 mm	PLANO	NEGRO
RG0502	50 x 50 mm	PLANO	NEGRO

Varios de Goma



CÓDIGO	MEDIDA	TIPO	COLOR
RG0401	15 x 62 mm	ESCALERA MULTIFUNCIONAL	NEGRO
RG0402	14 x 24 mm	ESCALERA MADERA	NEGRO
RG0403	REDONDO 21 mm	ESCALERA DIAGONAL	NEGRO
RG0404	DIAGONAL 20 x 60	ESCALERA RECTANGULAR	NEGRO
RG0405	27 mm	PARAGOLPE N5 CHICO	NEGRO
RG0406	38 mm	PARAGOLPE N5 GRANDE	NEGRO
RG0407	40 x 40 cm	PLACA ANTIVIBRATORIA	NEGRO